

SPECIFICATIONS	
Power	5.5kW / 7.5HP
Frequency	50Hz
Discharge	100mm / 4 inch female BSP
Weight (Excl cable)	85Kg
Solid Passage	10 mm
Phase	3ø
Voltage	415
Full Load Ampere	11.0
Maximum Liquid Temperature	0-40° C
Maximum Submersion Depth	30m (100 feet)
Motor type	Dry motor
Motor Speed	2 Pole (2800 rpm)
Motor Insulation	Class F
Motor Protection	IP68
Protector	Auto cut
Motor Bearings	Ball Type
Seal Method	Dual Mechanical seal Upper: Carbon/Ceramic Lower: Silicon/Silicon
Impeller Type	Enclosed Channel
Motor Cover Construction	FC-200 Cast Iron
Motor Casing Construction	304 Stainless Steel
Motor Shaft Construction	420J2 Stainless Steel
Pump Casing Construction	FC-200 Cast Iron
Outer Pump Jacket Construction	304 Stainless Steel
Impeller Construction	Hi-Chromium
Wear Ring	Hi-Chromium
Strainer Construction	304 Stainless Steel
Cable Material	H07RN-F



UMHDDN5500/100/3

MODEL NUMBER STRUCTURE

UMHDDN5500/100/3

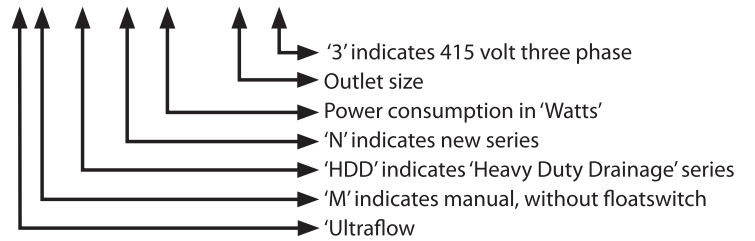

PERFORMANCE CURVES

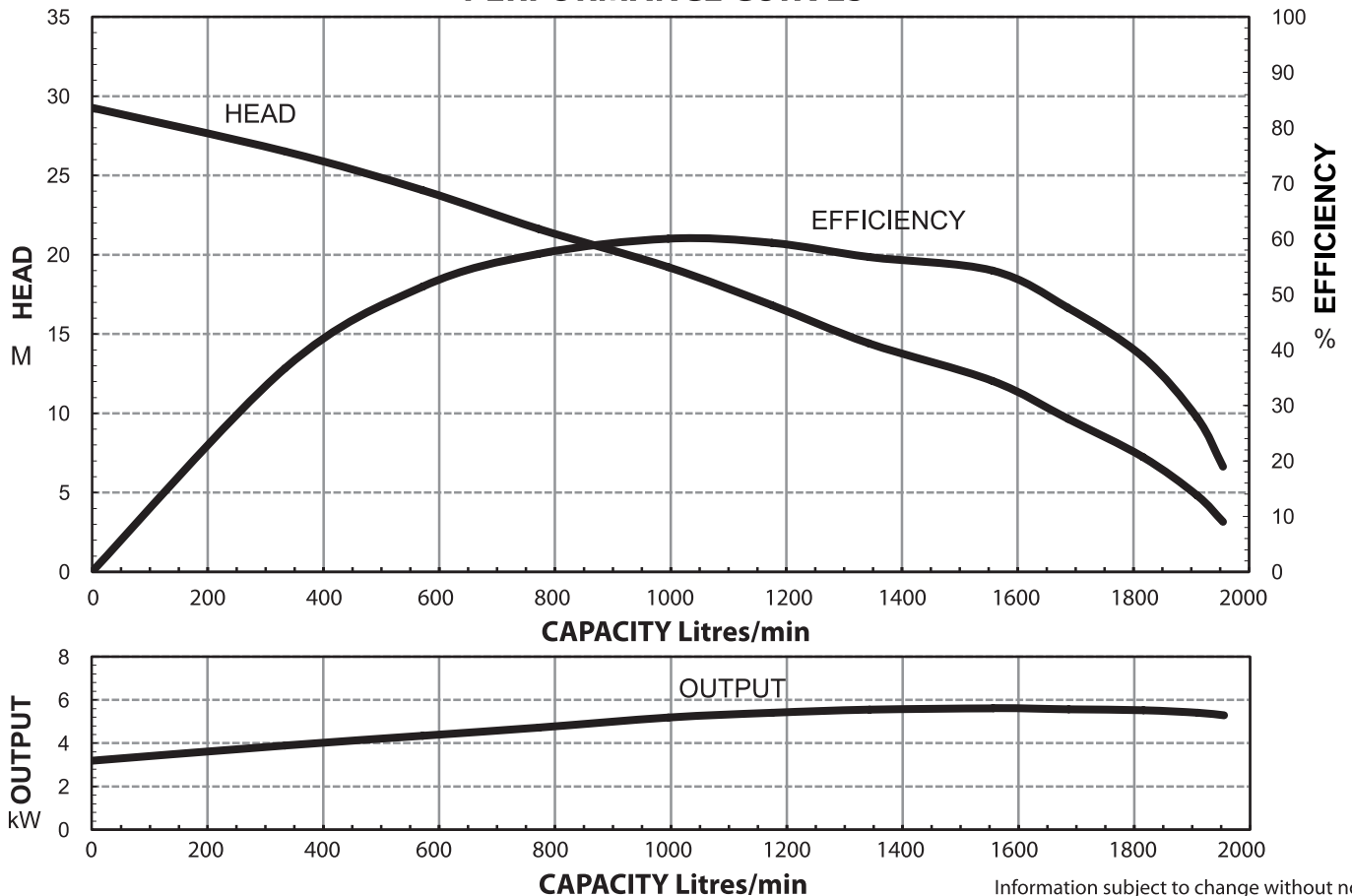

Information subject to change without notice.

SECTIONAL DRAWING & MATERIALS LIST

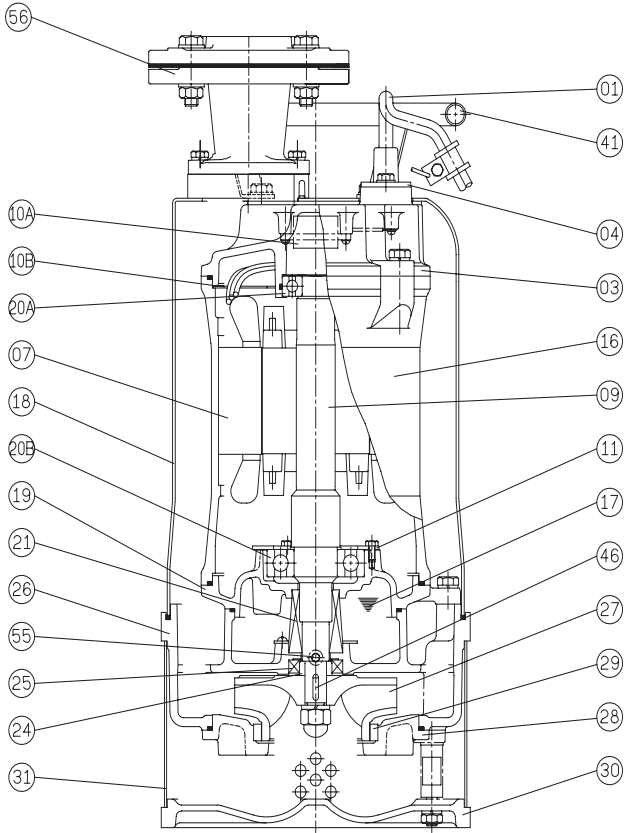

Part Number	Description	Material
01	Cable	HO7RN-F
03	Upper Motor Cap/ Upper Bearing Housing	Cast Iron FC-200
07	Motor Stator	
09	Shaft With (With Rotor)	(Shaft) Stainless Steel 420J2
10A	Auto Cut Out Overload	
10B	Auto Cut Out Plate	
11	Bearing Fixer	
16	Motor Casing	304 Stainless Steel
17	Lubricant	Turbine Oil
18	Outer Cover	304 Stainless Steel
19	Lower Bearing Housing	Cast Iron FC-200
20A	Upper Bearing	
20B	Lower Bearing	
21	Mechanical Seal	Upper: Carbon/Ceramic Lower: Silicon/Silicon
24	Oil Seal Bush	403 Stainless Steel
25	Oil Seal	Nitrile
26	Pump Casing	Cast Iron FC-200
27	Impeller	High Chromium HiCr
28	Casing Cover	Cast Iron FC-200
29	Wear Ring	High Chromium HiCr
30	Pump Base	Cast Iron FC-200
31	Strainer	304 Stainless Steel
41	Handle	304 Stainless Steel
46	Impeller Key	304 Stainless Steel
47	O'rings	
55	Oil Plug	304 Stainless Steel
56	Outlet Flange Kit	

To order spare parts as above, it will be necessary to add the model number of the pump after the code listed above. For example, a power lead for a UMHDDN5500/100/3 would be written as '01-UMHDDN5500/100/3'.

PUMP OUTLET DIMENSIONS

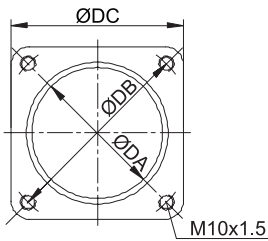

DIMENSIONS - mm		
DA	DB	DC
87	127	112

LKF4-175*127PT OUTLET FLANGE KIT DIMENSIONS

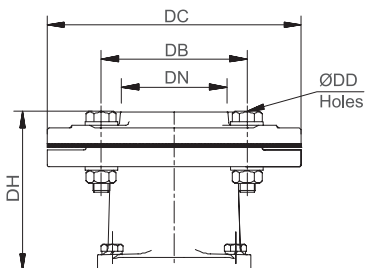

DIMENSIONS - mm					
DN	DB	DC	DD	DH	HOLES
100	165-190	225	18	119	8

DIMENSIONAL DRAWING

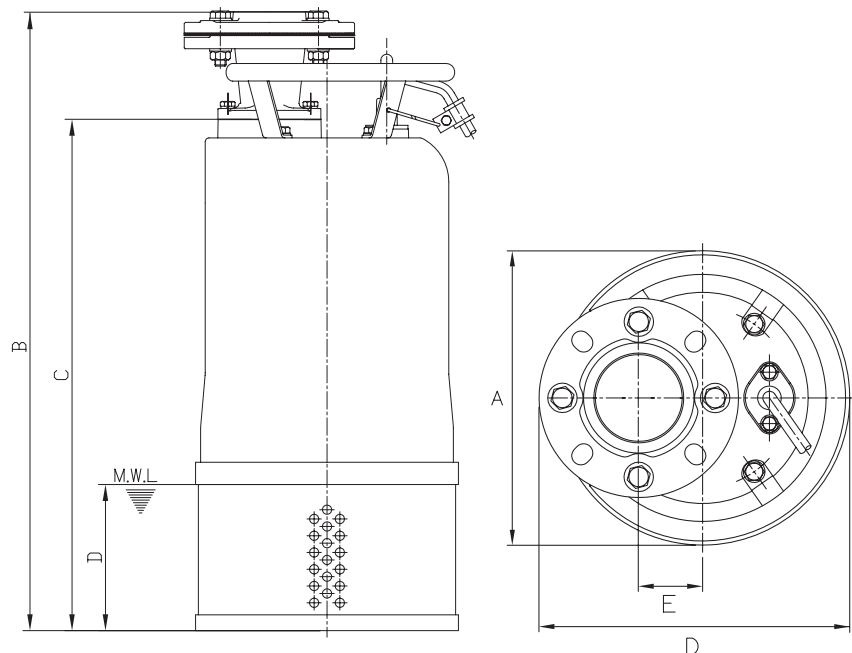

DIMENSIONS - mm				
UMHDDN5500/100/3				
A	B	C	D	E
286	669	550	318	62.5